

SOLUTIONS ÉLECTRONIQUES
ELECTRONIC SOLUTIONS



THG[®]
P A R I S

SOMMAIRE | SUMMARY



DÉTECTION DE PROXIMITÉ PROXIMITY SENSOR

PRÉSENTATION PRESENTATION.....	4
INFORMATIONS TECHNIQUES TECHNICAL INFORMATION.....	20



DÉTECTION INFRAROUGE INFRARED SENSOR

PRÉSENTATION PRESENTATION.....	8
INFORMATIONS TECHNIQUES TECHNICAL INFORMATION.....	22



COMMANDE ÉLECTRONIQUE TACTILE ELECTRONIC TOUCH CONTROL

PRÉSENTATION PRESENTATION.....	12
INFORMATIONS TECHNIQUES TECHNICAL INFORMATION.....	26



COLLECTIONS COLLECTIONS	36
FINITIONS FINISHES.....	46

ATTACH
TOP
W/
75



2x6
TRUS



WOOD BEAM SEE

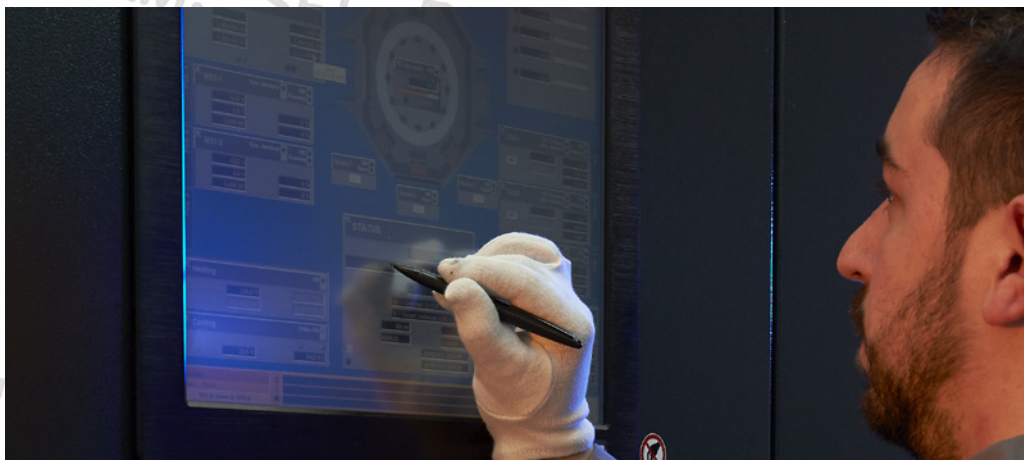

X-
SCALE: 3/4" = 1'-0"
ING DETAIL

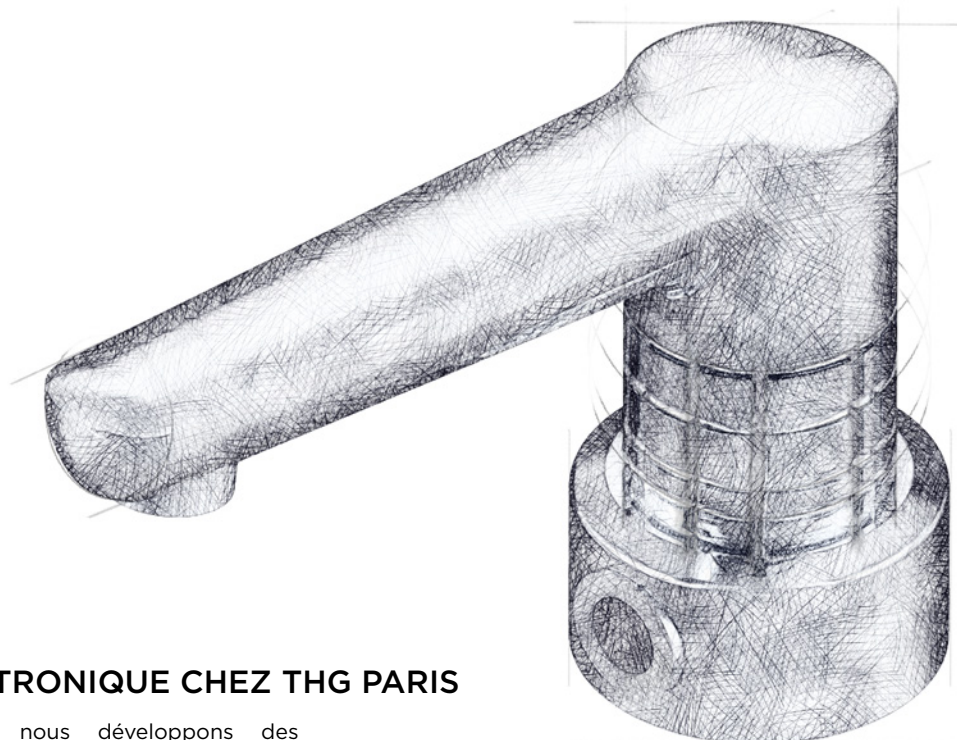

LA TECHNOLOGIE ÉLECTRONIQUE CHEZ THG PARIS

Depuis plus de 10 ans, nous développons des produits électroniques pour répondre à vos besoins. Notre bureau d'étude travaille sur différentes technologies intuitives :



DÉTECTION DE PROXIMITÉ



DÉTECTION INFRAROUGE



COMMANDE ÉLECTRONIQUE TACTILE

Grâce à notre savoir-faire, nous adaptons la technologie sans sacrifier le design pour vous proposer des collections esthétiques, fonctionnelles et simples à installer.

ELECTRONIC TECHNOLOGY AT THG PARIS

For over 10 years, we have been developing electronic products to meet your needs.

Our design office works on different intuitive technologies:



PROXIMITY SENSOR



INFRARED SENSOR



ELECTRONIC TOUCH CONTROL

Thanks to our know-how, we adapt the technology without sacrificing the design to offer you aesthetic, functional and easy to install collections.



DÉTECTION DE PROXIMITÉ

L'eau coule grâce à un simple mouvement à proximité du robinet.

- Pas de capteur visible
- Hygiénique
- Économies d'eau et d'énergie
- Disponible dans toutes les collections

Retrouvez les informations techniques page 20.

PROXIMITY SENSOR

The water flows with a simple movement near the tap.

- No visible sensor
- Hygienic
- Water and energy saving
- Available in all collections

See technical information on page 20.

4



G31.F01

Doré | Polished gold



MEN
←



U7G.A02

Chrome | Polished chrome



G04.F30

Or pâle | Soft gold



U9K.F33

PVD couleur bronze brown |
Brown bronze color PVD



DÉTECTION INFRAROUGE

Technologie par détection infrarouge : la cellule détecte la présence de l'utilisateur et déclenche l'ouverture automatique de l'eau.

- Hygiénique
- Économies d'eau et d'énergie
- Préconisé en hôtellerie

Retrouvez les informations techniques page 22.

INFRARED SENSOR

Infrared detection technology: the sensor detects the presence of the user and triggers an automatic flow of water.

- Hygienic
- Water and energy saving
- Recommended for hotels

See technical information on page 22.



A54.B01

Nickel | Polished nickel



Avec mitigeur pour régler manuellement la température
With deck mounted mixing valve for manual temperature control

G8A.F30

Or pâle | Soft gold



G25.F30

Or pâle | Soft gold



G29.C01

Nickel mat | Matt nickel



G5E.A02

Chrome | Polished chrome



U7G.A02

Chrome | Polished chrome

Disponible en version murale
ou sur gorge.

Available as wall-mounted
or integrated deck mount
versions.



G9E.D05

Bronze clair vernis mat |
Lacquered matt bronze

E

COMMANDE ÉLECTRONIQUE TACTILE

Une simple pression sur le bouton ouvre et ferme l'eau et la température se règle en le tournant.

- Grande souplesse de commande
- Confort et sécurité : régulation électronique de la température et du débit
- Visualisation de la montée en température par technologie LED
- Économies d'eau et d'énergie
- Préconisé en hôtellerie et en résidentiel privé

Retrouvez les informations techniques page 26.

ELECTRONIC TOUCH CONTROL

A simple press on the button opens and closes the water flow and the temperature is adjusted by turning it.

- High control flexibility
- Comfort and safety: electronic temperature and flow control
- Visualisation of the temperature rise by LED technology
- Saving water and energy
- Recommended for hotels and private homes

See technical information on page 26.





G25.F30
Or pâle | Soft gold



G7E.A02

Chrome | Polished chrome

14

Bouton utilisable avec des becs
muraux ou sur gorge
Control can be used with wall or deck
spouts



U7G.A02

Chrome | Polished chrome



A2U.A02
Chrome | Polished chrome

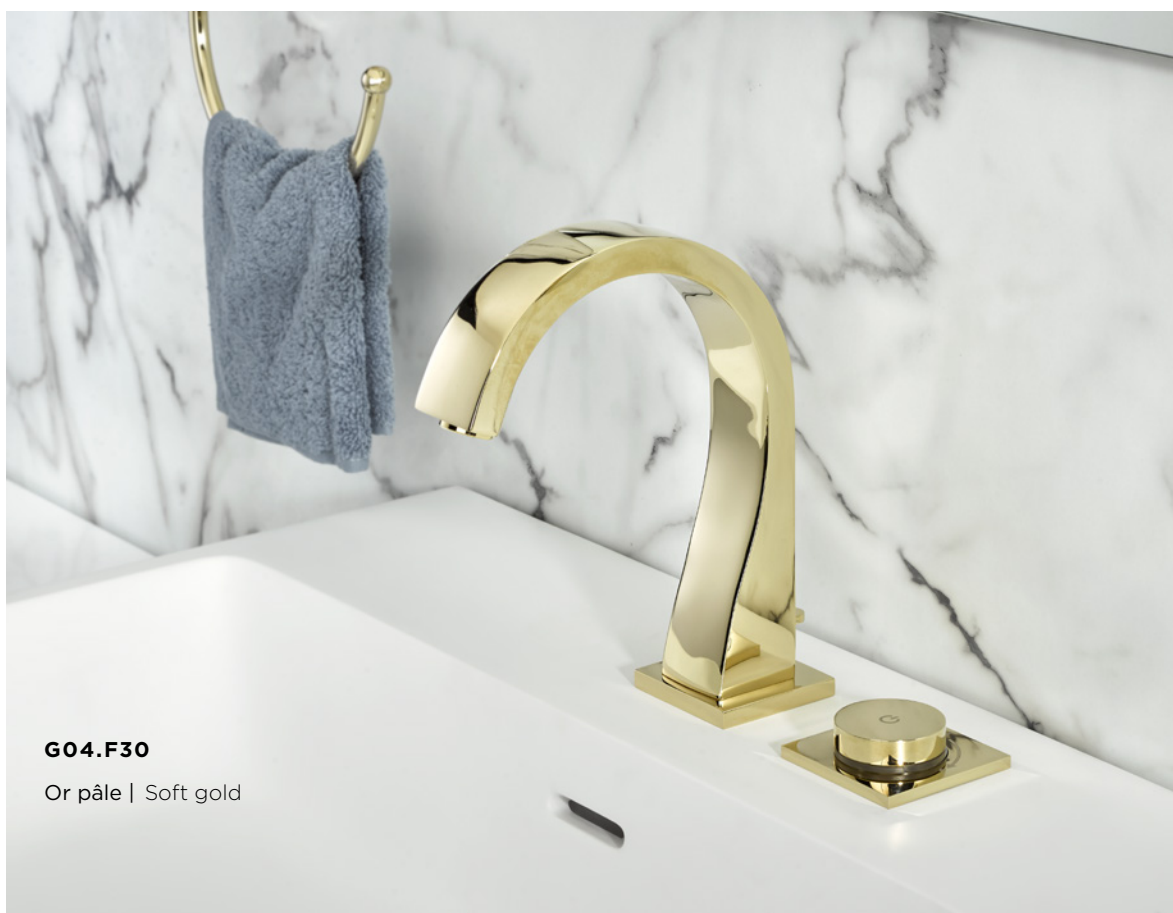

G04.F30
Or pâle | Soft gold

Fonction double : bain et douche
Dual function: bath and hand shower



U7G.A02

Chrome | Polished chrome

16



U7H.A02

Chrome | Polished chrome

Fonction simple : bouton pour douche
Simple function: button for hand shower



A4L.F30

Or pâle | Soft gold



U7G.H65

PVD couleur graphite mat |
Matt graphite color PVD

INFORMATIONS TECHNIQUES
TECHNICAL INFORMATION





DÉTECTION DE PROXIMITÉ : ÉLÉMENTS TECHNIQUES

PROXIMITY SENSOR: TECHNICAL ELEMENTS

PRINCIPE | PRINCIPLE

Déclenchement sans contact. Quand la main approche à moins de 5 cm du bec, l'eau s'écoule et stoppe 2 secondes après le retrait des mains.
 Touchless triggering. At a distance less than 5 cm from the spout, water flows and stops 2 seconds after hands are removed.

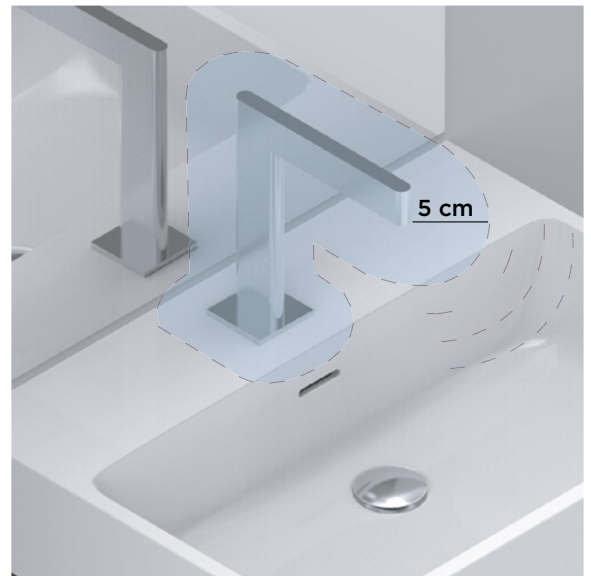

ALIMENTATION | POWER SUPPLY



6 x LR6

COMPOSITION TECHNIQUE | TECHNICAL COMPOSITION

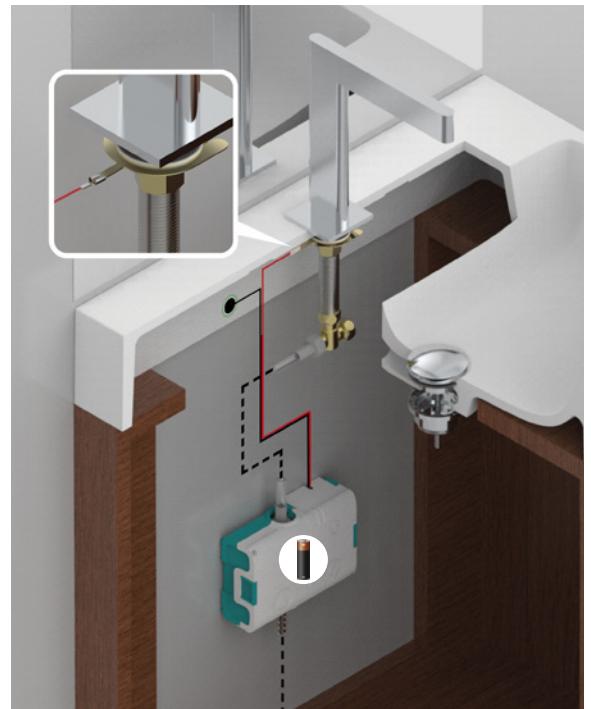

20

MODE NETTOYAGE | CLEANING MODE

La fonction nettoyage permet de bloquer la détection et donc d'éviter que l'eau ne coule quand on approche ses mains. Pour activer la fonction nettoyage, appuyer 60 secondes sur le bouton de contrôle du boîtier.
 The cleaning function allows you to block the detection and therefore prevent water from flowing when you approach your hands: this is very practical when cleaning. To activate the cleaning function, press the control button on the casing for 60 seconds.

NORMES | CERTIFICATIONS



IP55

NOTICE D'INSTALLATION
 INSTALLATION INSTRUCTIONS





COMMENT COMMANDER DES BECS À DÉTECTION DE PROXIMITÉ ? HOW TO SPECIFY A PROXIMITY SENSOR BASIN SET?

1 CHOISIR UNE COLLECTION | CHOOSE A COLLECTION

Exemple de référence à indiquer | Example of part number to use : **G1T - 170E**

Bec | Standard spout : 170E

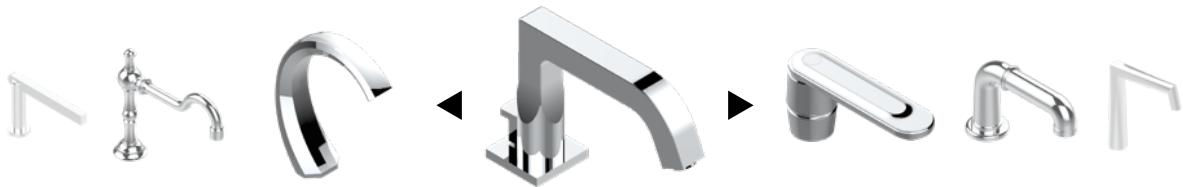

Bec haut | High spout : 172E



Retrouvez toutes nos collections | Find all our collections
Page 36

21

2 RÉGLAGE DE LA TEMPÉRATURE* | INDICATE METHOD OF SETTING THE TEMPERATURE*



5999

Mitigeur thermostatique 1/2", à dissimuler
1/2" Concealed wall mounted thermostat



6532

Mitigeur progressif sur gorge
Rim mounted progressive mixer

3 CHOISIR UN SIPHON* | CHOOSE A TRAP*



308T

Siphon culot réglable
Adjustable bottle trap



309/S

Siphon design apparent
Bottle trap only for waste



315L

Siphon tube
Adjustable «P» trap

* Optionnel | Optional



DÉTECTION INFRAROUGE SUR GORGE : ÉLÉMENTS TECHNIQUES

RIM MOUNTED INFRARED SENSOR: TECHNICAL ELEMENTS

PRINCIPE | PRINCIPLE

Déclenchement sans contact. Quand la main approche à une distance comprise entre 5 et 25 cm, l'eau s'écoule et stoppe 2 secondes après le retrait des mains.

Touchless triggering. At a distance of 5 to 25 cm, water flows out and stops 2 seconds after hands are removed.

ALIMENTATION | POWER SUPPLY



110 - 220 V
Secteur | Electrical outlet

Ou / Or



Pile 6V | Battery

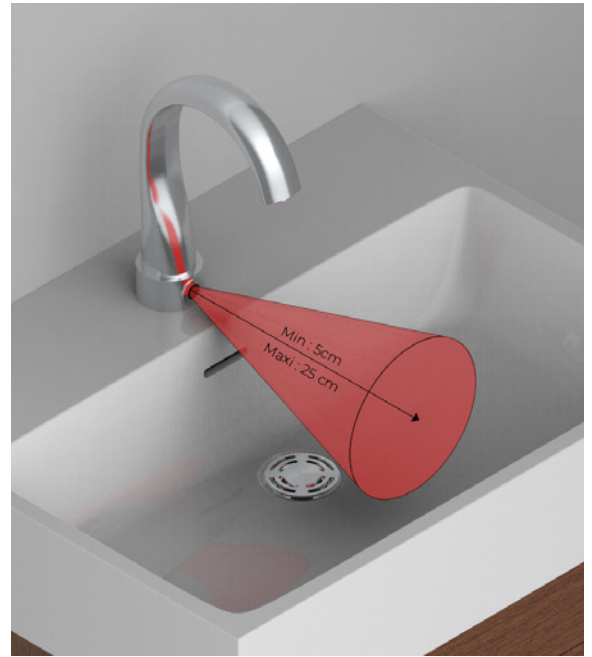

COMPOSITION TECHNIQUE | TECHNICAL COMPOSITION

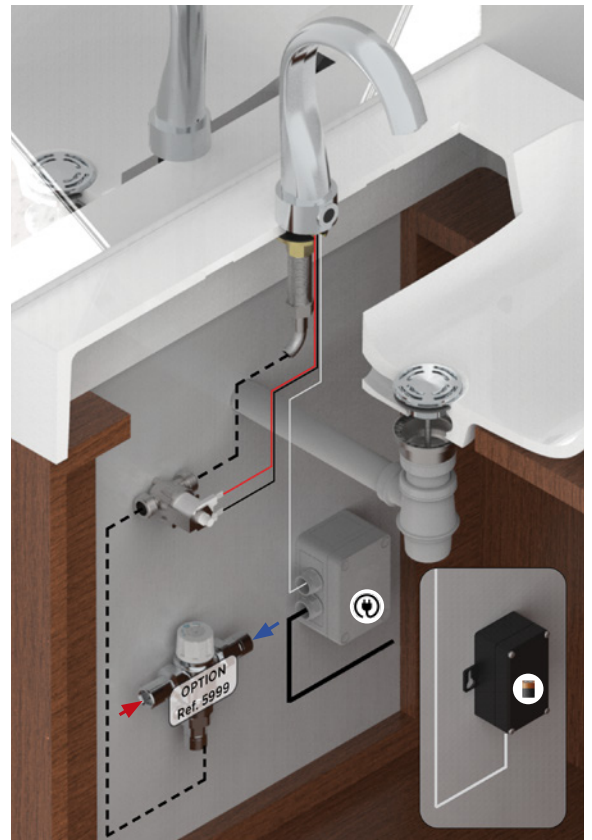

NORMES | CERTIFICATIONS



IP65

NOTICE D'INSTALLATION
INSTALLATION INSTRUCTIONS





COMMENT COMMANDER DES BECS INFRAROUGE SUR GORGE ? HOW TO SPECIFY A RIM MOUNTED INFRARED SPOUT?

1 CHOISIR UNE COLLECTION | CHOOSE A COLLECTION

Exemple de référence à indiquer | Example of part number to use: **G1T**

Bec | Standard spout: 170IRS / 170IRB



Retrouvez toutes nos collections | Find all our collections
Page 38

2 INDiquer LA RÉFÉRENCE DE L'ARTICLE SELON LE TYPE D'ALIMENTATION INDICATE THE SPOUT PART NUMBER ACCORDING TO THE TYPE OF SUPPLY



170IRS

Bec infrarouge sur gorge, sur secteur
Rim mounted infrared spout, on mains



170IRB

Bec infrarouge sur gorge, à piles
Rim mounted infrared spout, battery operated

23

3 RÉGLAGE DE LA TEMPÉRATURE* | INDICATE METHOD OF SETTING THE TEMPERATURE*

5999

Mitigeur thermostatique 1/2",
à dissimuler

1/2" Concealed wall mounted
thermostat



6532

Mitigeur progressif sur gorge
Rim mounted progressive mixer



Collectif | Collective



5200AE

Mitigeur thermostatique à encastrer
Concealed thermostatic mixing valve



5100BR

4 CHOISIR UNE BONDE* | CHOOSE A WASTE*



316

Vidage clic clac
Click waste



309/B

Bonde à écoulement libre
Free-flow basin waste
with grid

* Optionnel | Optional

5 CHOISIR UN SIPHON* | CHOOSE A TRAP*



308T

Siphon culot
réglable
Adjustable bottle
trap



309/S

Siphon design
apparent
Bottle trap only
for waste



315L

Siphon tube
Adjustable «P»
trap



DÉTECTION INFRAROUGE MURALE : ÉLÉMENTS TECHNIQUES

WALL-MOUNTED INFRARED SENSOR: TECHNICAL ELEMENTS

PRINCIPE | PRINCIPLE

Déclenchement sans contact. Quand la main approche à une distance comprise entre 5 et 25 cm, l'eau s'écoule et stoppe 2 secondes après le retrait des mains.

Touchless triggering. At a distance of 5 to 25 cm, water flows out and stops 2 seconds after hands are removed.

ALIMENTATION | POWER SUPPLY



Secteur | Electrical outlet

Ou / Or



Pile 6V | Battery

NORMES | CERTIFICATIONS



IP65

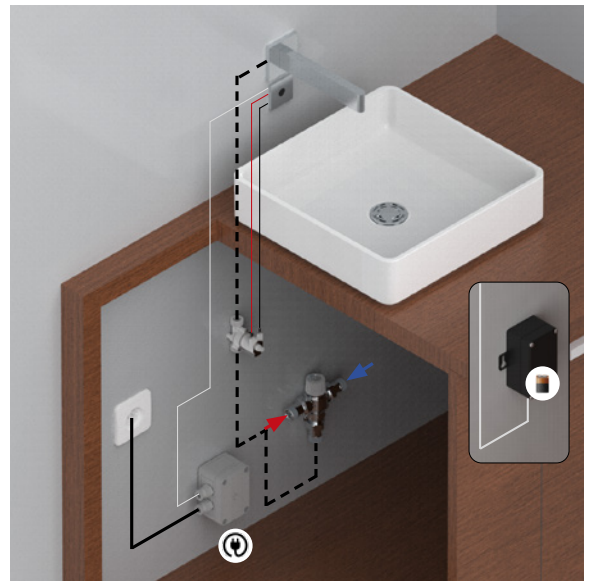
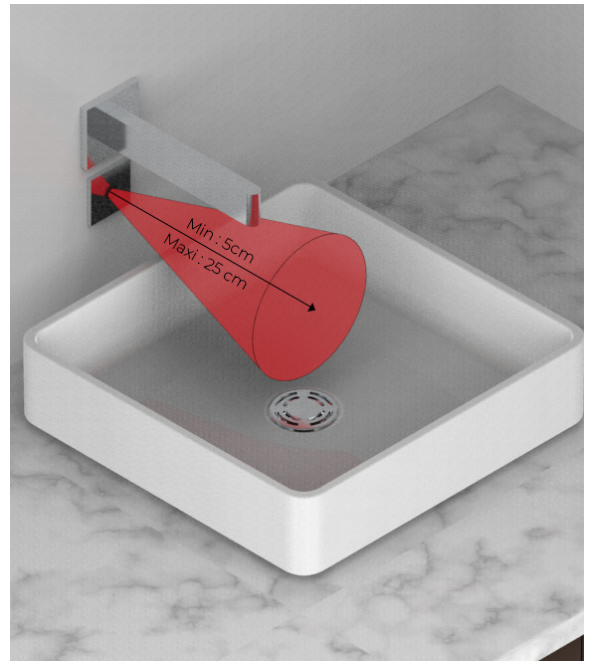

NOTICE D'INSTALLATION
INSTALLATION INSTRUCTIONS





COMMENT COMMANDER DES BECS INFRAROUGE MURAUX ? HOW TO SPECIFY A WALL-MOUNTED INFRARED SPOUT?

1 CHOISIR UNE COLLECTION | CHOOSE A COLLECTION

Exemple de référence à indiquer | Example of part number to use: **G1T - 22GAB**



Retrouvez toutes nos collections | Find all our collections
Page 40

2 INDIQUER LA RÉFÉRENCE DE L'ARTICLE ET CHOISIR LA CELLULE INDICATE THE SPOUT PART NUMBER ALONG WITH POWER SOURCE AND TRIM SHAPE



22GAB
Bec mural
Wall mounted spout

+



Ou / Or



Carré | Square



6702C

Ou / Or

Rond | Round



6702R



Carré | Square



6702CB

Ou / Or

Rond | Round



6702RB

25

3 RÉGLAGE DE LA TEMPÉRATURE* | INDICATE METHOD OF SETTING THE TEMPERATURE*



5999
Mitigeur thermostatique 1/2",
à dissimuler
1/2" Concealed wall mounted
thermostat

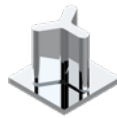

6532
Mitigeur progressif sur gorge
Rim mounted progressive mixer

Collectif | Collective

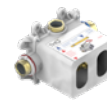

5200AE

+



5100BR

Mitigeur thermostatique à encastrer
Concealed thermostatic mixing valve

4 CHOISIR UNE BONDE* | CHOOSE A WASTE*



316
Vidage clic clac
Click waste



309/B
Bonde à écoulement libre
Free-flow basin waste
with grid

5 CHOISIR UN SIPHON* | CHOOSE A TRAP*



308T
Siphon culot
réglable
Adjustable bottle
trap



309/S
Siphon design
apparent
Bottle trap only
for waste



315L
Siphon tube
Adjustable «P»
trap

* Optionnel | Optional

E COMMANDE ÉLECTRONIQUE TACTILE : ÉLÉMENTS TECHNIQUES ELECTRONIC TOUCH CONTROL: TECHNICAL ELEMENTS

PRINCIPE | PRINCIPLE

Déclenchement de l'eau et réglage de la température par bouton. La couleur de la lumière indique la température.

Water triggering and temperature setting by control. The colour of the light indicates the temperature.

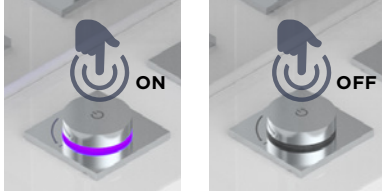

ALIMENTATION | POWER SUPPLY



110 - 220 V
Secteur | Electrical outlet

SÉCURITÉ TEMPÉRATURE | TEMPERATURE SAFETY

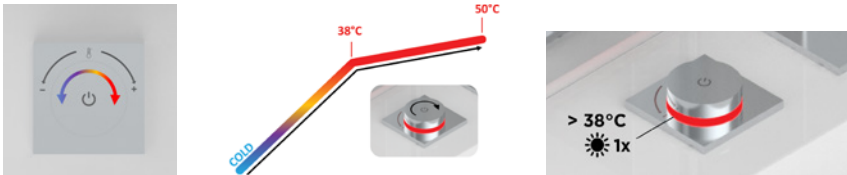

26

PRÉRÉGLAGES | PRESETTINGS



Eau froide |
Cold water



Eau à 30°C |
86°F water



Eau à 38°C |
100°F water

MODE NETTOYAGE | CLEANING MODE

Pour éviter que le robinet ne s'ouvre pendant le nettoyage, la fonction aquastop désactive temporairement le capteur. Pour activer cette fonction, appuyez sur le bouton de commande et le capteur reste inactif pendant 60s.

To ensure that the faucet doesn't open during cleaning, the aquastop function temporarily deactivates the sensor. To activate this function, press the control button and the sensor remains inactive for 60s.



DONNÉES TECHNIQUES | TECHNICAL DATA

- Débit lavabo selon norme en vigueur | Washbasin flow rate according to standard
- Pression recommandée | Recommended pressure: 0,5 à 5 bars

NORMES | CERTIFICATIONS



IPX4

E COMMANDE ÉLECTRONIQUE TACTILE : MITIGEUR DE LAVABO ELECTRONIC TOUCH CONTROL: RIM MOUNTED BASIN SPOUT

ALIMENTATION | POWER SUPPLY



110 - 220 V
Secteur | Electrical outlet
2 mètres de câble | 2 metres of cable

COMPOSITION TECHNIQUE | TECHNICAL COMPOSITION

170V = + + +

172V = + + +

NOTICE D'INSTALLATION
INSTALLATION INSTRUCTIONS

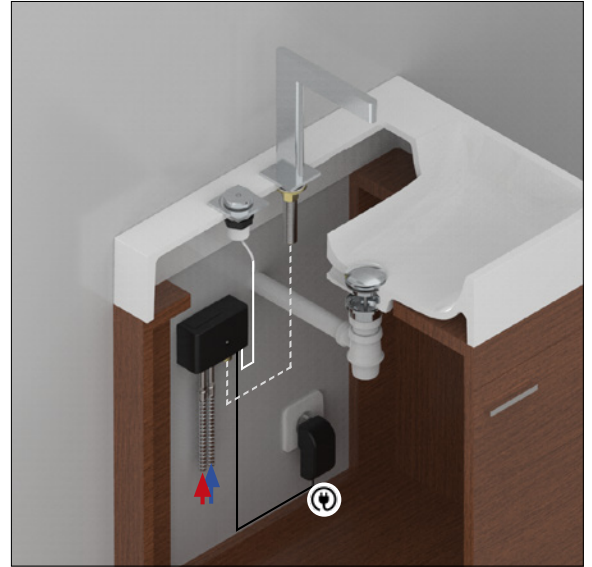

E COMMENT COMMANDER DES MITIGEURS DE LAVABO TACTILES ? HOW TO SPECIFY TOUCH CONTROL RIM MOUNTED SPOUT?

1 CHOISIR UNE COLLECTION | CHOOSE A COLLECTION

Exemple de référence à indiquer | Example of part number to use: **G9A - 170V**

Bec | Standard spout: 170V



Bec haut | High spout: 172V



Retrouvez toutes nos collections | Find all our collections
Page 36

2 CHOISIR UN SIPHON* | CHOOSE A TRAP*



308T
Siphon culot réglable
Adjustable bottle trap



309/S
Siphon design apparent
Bottle trap only for waste



315L
Siphon tube
Adjustable «P» trap

* Optionnel | Optional

E COMMANDE ÉLECTRONIQUE TACTILE : MITIGEUR DE LAVABO MURAL ELECTRONIC TOUCH CONTROL: WALL MOUNTED BASIN SPOUT

ALIMENTATION | POWER SUPPLY



110 - 220 V
Secteur | Electrical outlet
2 mètres de câble | 2 metres of cable

NOTICE D'INSTALLATION
INSTALLATION INSTRUCTIONS

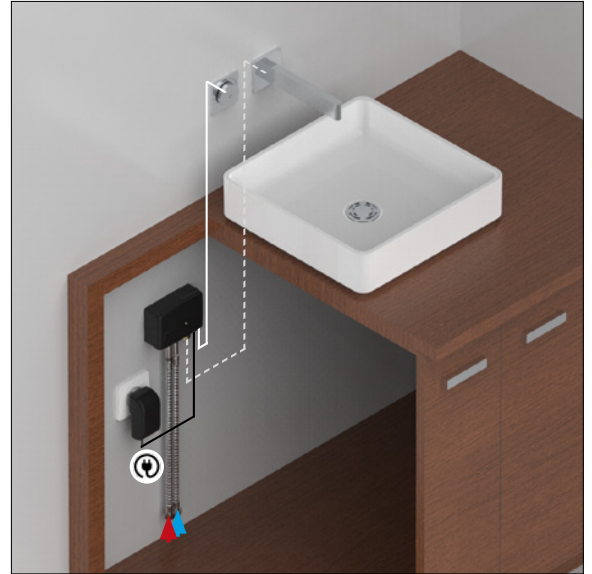

E COMMENT COMMANDER DES MITIGEURS DE LAVABO TACTILES MURAUX ? HOW TO ORDER TOUCH CONTROL WALL MOUNTED SPOUT?

1 CHOISIR UNE COLLECTION | CHOOSE A COLLECTION

Exemple de référence à indiquer | Example of part number to use: **G9A - 22GAB**



Retrouvez toutes nos collections | Find all our collections
Page 40

2 INDIQUER LA RÉFÉRENCE DE L'ARTICLE ET CHOISIR LE BOUTON INDICATE THE SPOUT PART NUMBER AND CHOOSE THE BUTTON SHAPE; ADD SYSTEM



22GAB
Bec mural
Wall mounted spout

Carré | Square



6770B

Rond | Round



6770RB

Ou / Or

+

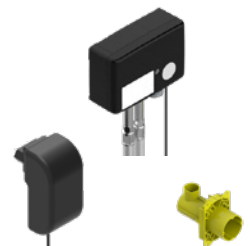

6770A

3 CHOISIR UNE BONDE* | CHOOSE A WASTE*



316
Vidage clic clac
Click waste



309/B
Bonde à écoulement libre
Free-flow basin waste with grid

4 CHOISIR UN SIPHON* | CHOOSE A TRAP*



308T
Siphon culot réglable
Adjustable bottle trap



309/S
Siphon design apparent
Bottle trap only for waste



315L
Siphon tube
Adjustable «P» trap

* Optionnel | Optional



E COMMANDE ÉLECTRONIQUE TACTILE : BAIN DOUCHE ELECTRONIC TOUCH CONTROL: BATHTUB

ALIMENTATION | POWER SUPPLY



110 - 220 V
Secteur | Electrical outlet
6 mètres de câble | 6 metres of cable

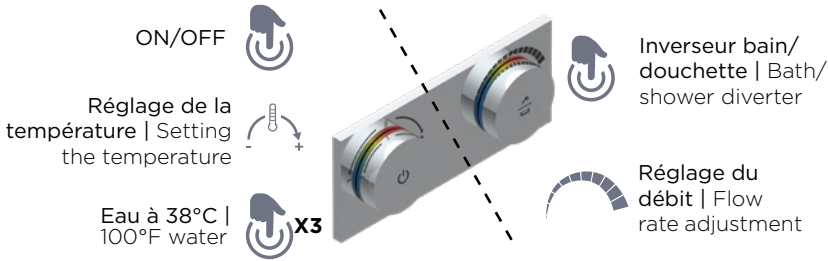

NOTICE D'INSTALLATION
INSTALLATION INSTRUCTIONS

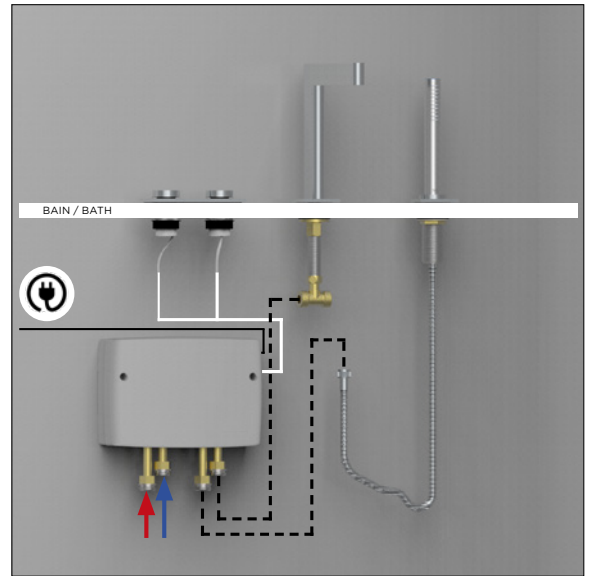

E COMMENT COMMANDER DU TACTILE POUR BAIN DOUCHE ? HOW TO SPECIFY TOUCH CONTROL FOR BATHTUB?

1 CHOISIR UNE SOLUTION | CHOOSE A SOLUTION

30

Sur gorge | Rim mounted

Mural | Wall mounted

2 CHOISIR UN BEC DE BAIN CHOOSE A BATH SPOUT



2 CHOISIR UN BEC DE BAIN CHOOSE A BATH SPOUT

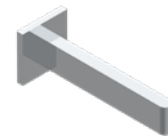

3 CHOISIR LES BOUTONS | CHOOSE THE BUTTONS

Carré | Square Rond | Round



6760D

6760DR

Inclus | Included

3 CHOISIR LES BOUTONS | CHOOSE THE BUTTONS

Carré | Square Rond | Round



6770DB

6770DRB

6770DA

4 CHOISIR UNE DOUCHETTE CHOOSE A HAND SHOWER



4 CHOISIR UNE DOUCHETTE CHOOSE A HAND SHOWER



EXEMPLE DE COMPOSITION | EXAMPLE OF COMPOSITION

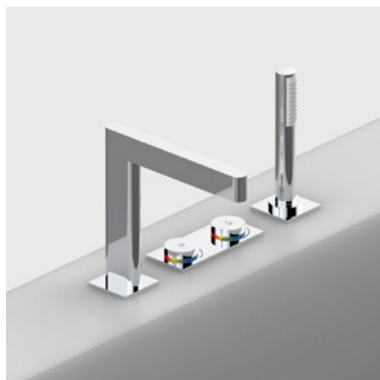

29SG - 6760D - 60A

Ensemble mitigeur de bain à commande électronique avec vidage
Rim mounted bath mixer with electronic control and pop-up waste



U9A - 29SGB

G00 - 6760DR

U9A - 60A



G04 - 29SG

G00 - 6760D

G04 - 58



42SGB - 6770DB - 6770DA - 54

Ensemble mitigeur de bain mural, à commande électronique avec vidage
Wall mounted bath mixer with electronic control and pop-up waste



U9A - 42GB

G00 - 6770DRB

G00 - 6770DA

U9A - 54

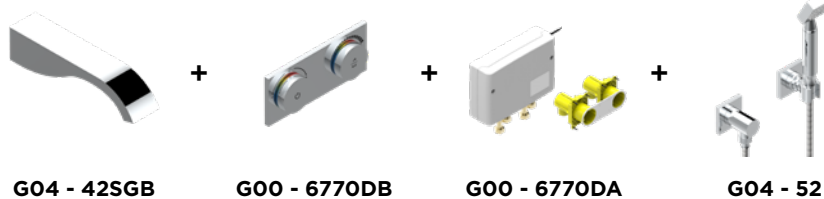

G04 - 42SGB

G00 - 6770DB

G00 - 6770DA

G04 - 52



G7A.F30

Or pâle | Soft Gold

E COMMANDE ÉLECTRONIQUE TACTILE : BAIN AVEC DOUCHETTE SEULE ELECTRONIC TOUCH CONTROL: BATHTUB WITH HAND SHOWER CONTROL ONLY

ALIMENTATION | POWER SUPPLY



110 - 220 V
Secteur | Electrical outlet
2 mètres de câble | 2 metres of cable

NOTICE D'INSTALLATION INSTALLATION INSTRUCTIONS

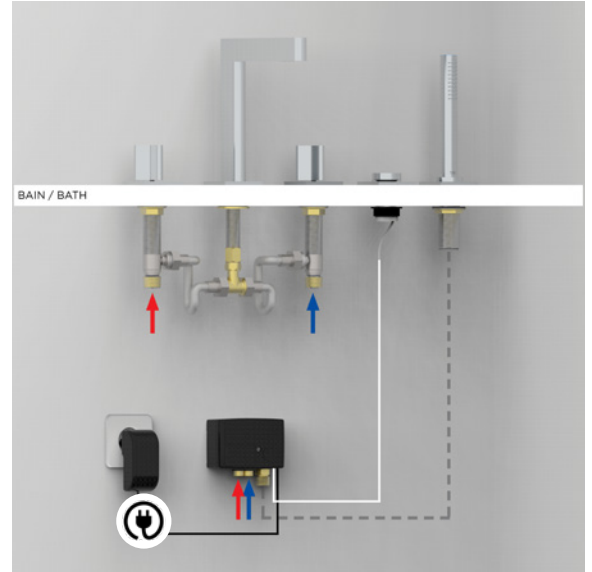

E COMMENT COMMANDER DU TACTILE POUR BAIN AVEC DOUCHETTE SEULE ? HOW TO ORDER TOUCH CONTROL FOR BATHTUB WITH HAND SHOWER ONLY?

1 CHOISIR UN MÉLANGEUR | CHOOSE A MIXER

Sur gorge | Rim mounted Mural | Wall mounted



Ou / Or

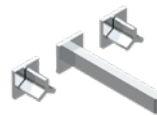

32

2 CHOISIR L'EMPLACEMENT DE LA DOUCHETTE | CHOOSE THE LOCATION OF THE HAND SHOWER

Sur gorge | Rim mounted

Mural | Wall mounted

3 CHOISIR LE BOUTON | CHOOSE THE BUTTON

Carré | Square Rond | Round



Ou / Or



+



6760

6760R

Inclus | Included

3 CHOISIR LE BOUTON | CHOOSE THE BUTTON

Carré | Square Rond | Round



Ou / Or



+

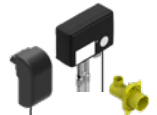

6770B

6770RB

6770A

4 CHOISIR UNE DOUCHETTE CHOOSE A HAND SHOWER



4 CHOISIR UNE DOUCHETTE CHOOSE A HAND SHOWER



EXEMPLE DE COMPOSITION | EXAMPLE OF COMPOSITION



25SG - 6760 - 60A

Ensemble mélangeur de bain avec douchette eau mitigée électronique

Bath mixer set with electronic water mixer and hand shower



G29 - 25SGH

G00 - 6760R

U9A - 60A

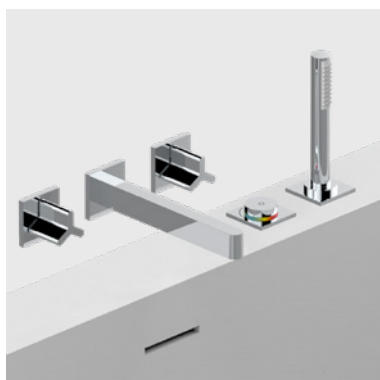

41SGB - 40AC - 6760 - 60A

Ensemble mélangeur de bain mural avec douchette eau mitigée électronique sur gorge

Wall mounted bath mixer and deck mounted handshower

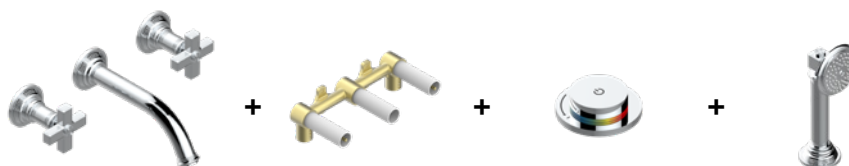

U9A - 41GB

G00 - 40AC

G00 - 6760R

U9A - 60A



U7G.A02

Chrome | Polished chrome

E COMMANDE ÉLECTRONIQUE TACTILE : DOUCHE DEUX FONCTIONS ELECTRONIC TOUCH CONTROL: DUAL FUNCTION SHOWER

ALIMENTATION | POWER SUPPLY



110 - 220 V
Secteur | Electrical outlet
6 mètres de câble | 6 metres of cable

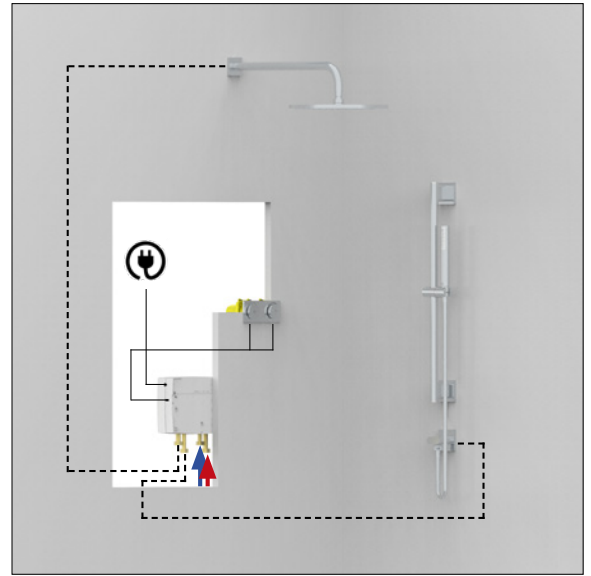
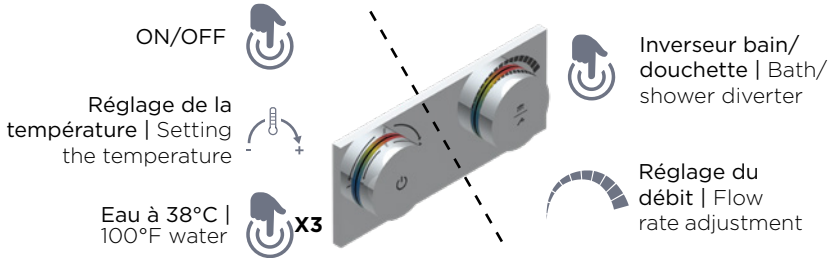

NOTICE D'INSTALLATION
INSTALLATION INSTRUCTIONS



E COMMENT COMMANDER DU TACTILE POUR UNE DOUCHE DEUX FONCTIONS ? HOW TO SPECIFY TOUCH CONTROL FOR A DUAL FUNCTION SHOWER?

34

1 CHOISIR UNE COLLECTION ET UN MODÈLE DE DOUCHETTE CHOOSING A COLLECTION AND MODEL OF HAND SHOWER

Exemple de référence à indiquer | Example of part numbers to indicate : **U4A - 52**



Retrouvez toutes nos collections sur | Find all our collections on
WWW.THG-PARIS.FR

2 CHOISIR LES BOUTONS | CHOOSE THE BUTTONS

Carré | Square

Rond | Round



Ou / Or



+

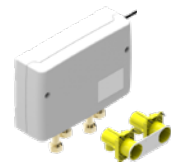

6772DB

6772DRB

6770DA

3

CHOISIR UNE POMME DE DOUCHE | CHOOSING A SHOWER HEAD

Bras | Arm

(Choisir la collection + le modèle | Choose the collection + the model)



82V



83



84BC



84C



84L



Pomme | Shower head



281C



280C



284EP



280EP



281EP



286P



286



187



281R



280R



281T



288L

Ou / Or

Plafond de douche | Sky shower

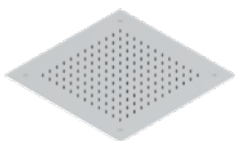

493

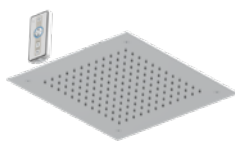

491



487



490

COLLECTIONS - BECS DE LAVABO | BASIN SPOUT



G04



G79



G5E



U7G



G1T



G6A



U4A



A9F



U2D



U2M



G4P



G8A



G31



G24



G25



A35



G5A



G7E



G7A



G7C

36



U2A



U93



U9A



U9K



G9A



G9C



G9E



G9G



G9J



U8D



U8F



U8H



U8K



G2T



G69



G29



A54

170E - 172E | 170V - 172V

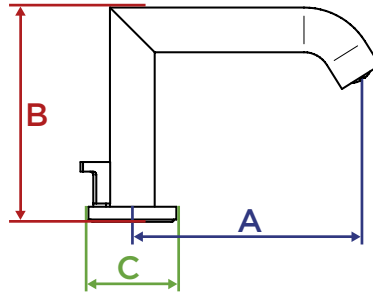

mm : millimètre
inch : pouce

COLLECTIONS	REFERENCES	A		B		C	
		mm	inch	mm	inch	mm	inch
G04	170E 170V	136	5 3/8"	208	8 1/4"	60 x 60	2 3/8" x 2 3/8"
G79	170E 170V	119	4 5/8"	168	6 5/8"	55 x 55	2 1/8" x 2 1/8"
G5E	170E 170V	179	7"	262	10 3/8"	50 x 50	2" x 2"
U7G	170E 170V	158	6 1/4"	220	8 5/8"	65 x 65	2 1/2" x 2 1/2"
G1T	170E 170V	155	6 1/8"	131	5 1/8"	55 x 55	2 1/8" x 2 1/8"
G6A	170E 170V	180	7 1/8"	246	9 3/4"	Ø 42	Ø 1 5/8"
U4A	170E 170V	136	5 3/8"	209	8 1/4"	Ø 60	Ø 2 3/8"
A9F	170E 170V	135	5 3/8"	208	8 1/4"	Ø 65	Ø 2 1/2"
U2D	170E 170V	135	5 3/8"	250	9 7/8"	42 x 60	1 5/8" x 2 3/8"
U2M	170E 170V	113	4 1/2"	207	8 1/8"	60 x 47	2 3/8" x 1 7/8"
G4P	170E 170V	160	6 1/4"	282	11 1/8"	Ø 60	Ø 2 3/8"
G8A	170E 170V	160	6 1/4"	288	11 3/8"	Ø 57	Ø 2 1/4"
G31	172E 172V	227	8 7/8"	344	13 1/2"	Ø 67	Ø 2 5/8"
G24	170E 170V	142	5 5/8"	127	5"	Ø 72	Ø 2 7/8"
G25	170E 170V	200	7 7/8"	204	8"	Ø 55	Ø 2 1/8"
A35	170E 170V	143	5 5/8"	133	5 1/4"	Ø 55	Ø 2 1/8"
G5A	170E 170V	144	5 5/8"	130	5 1/8"	Ø 44	Ø 1 3/4"
	172E 172V	160	6 1/4"	282	11 1/8"	Ø 44	Ø 1 3/4"
G7E	170E 170V	180	7 1/8"	158	6 1/4"	Ø 55	Ø 2 1/8"
	172E 172V	150	5 7/8"	238	9 3/8"	Ø 55	Ø 2 1/8"
G7A	170E 170V	150	5 7/8"	127	5"	Ø 60	Ø 2 3/8"
G7C	170E 170V	150	5 7/8"	129	5 1/8"	Ø 60	Ø 2 3/8"
U2A	170E 170V	178	7"	143	5 5/8"	Ø 50	Ø 2"
U93	170E 170V	163	6 3/8"	106	4 1/8"	Ø 65	Ø 2 1/2"
U9A	170E 170V	140	5 1/2"	104	4 1/8"	Ø 60	Ø 2 3/8"
	172E 172V	150	5 7/8"	250	9 7/8"	Ø 60	Ø 2 3/8"
U9K	170E 170V	140	5 1/2"	104	4 1/8"	Ø 60	Ø 2 3/8"
	172E 172V	150	5 7/8"	250	9 7/8"	Ø 60	Ø 2 3/8"
G9A	170E 170V	140	5 1/2"	102	4"	Ø 64	Ø 2 1/2"
	172E 172V	140	5 1/2"	173	6 3/4"	Ø 64	Ø 2 1/2"
G9C	170E 170V	140	5 1/2"	102	4"	Ø 64	Ø 2 1/2"
	172E 172V	140	5 1/2"	173	6 3/4"	Ø 64	Ø 2 1/2"
G9E	170E 170V	140	5 1/2"	102	4"	Ø 64	Ø 2 1/2"
	172E 172V	140	5 1/2"	173	6 3/4"	Ø 64	Ø 2 1/2"
G9G	170E 170V	140	5 1/2"	102	4"	Ø 64	Ø 2 1/2"
	172E 172V	140	5 1/2"	173	6 3/4"	Ø 64	Ø 2 1/2"
G9J	170E 170V	140	5 1/2"	102	4"	Ø 64	Ø 2 1/2"
	172E 172V	140	5 1/2"	173	6 3/4"	Ø 64	Ø 2 1/2"
U8D	170E 170V	152	6"	93	3 5/8"	Ø 48	Ø 1 7/8"
U8F	170E 170V	152	6"	93	3 5/8"	Ø 48	Ø 1 7/8"
U8H	170E 170V	152	6"	93	3 5/8"	Ø 48	Ø 1 7/8"
U8K	170E 170V	152	6"	93	3 5/8"	Ø 48	Ø 1 7/8"
G2T	170E 170V	140	5 1/2"	76	3"	Ø 60	Ø 2 3/8"
	172E 172V	151	6"	103	4 1/8"	Ø 60	Ø 2 3/8"
G69	170E 170V	140	5 1/2"	77	3"	Ø 55	Ø 2 1/8"
	172E 172V	151	6"	102	4"	Ø 55	Ø 2 1/8"
G29	170E 170V	142	5 5/8"	78	3 1/8"	Ø 64	Ø 2 1/2"
	172E 172V	148	5 3/4"	136	5 3/8"	Ø 54	Ø 2 1/8"
A54	170E 170V	141	5 1/2"	81	3 1/4"	Ø 60	Ø 2 3/8"
	172E 172V	148	5 3/4"	143	5 5/8"	Ø 60	Ø 2 3/8"

COLLECTIONS - BECS DE LAVABO INFRAROUGE | INFRARED BASIN SPOUTS



G79



G5E



G1T



G8A



G6A



A9F



U4A



A35



G7E



G7A



G7C



U2A



G29



U93



U9A



U9K



G9A



G9C



G9E



G9G



G9J



A54

170IRS | 170IRB

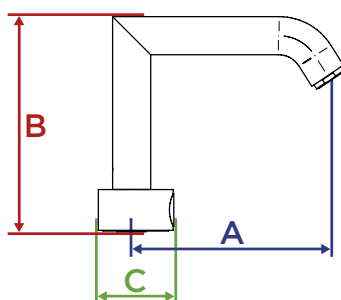

mm : millimètre
inch : pouce

COLLECTIONS	REFERENCES	A		B		C	
		mm	inch	mm	inch	mm	inch
G79	170IRS 170IRB	119	4 5/8"	190	7 1/2"	50 x 50	2" x 2"
G5E	170IRS 170IRB	179	7"	291	11 1/2"	60 x 60	2 3/8" x 2 3/8"
G1T	170IRS 170IRB	149	5 7/8"	153	6"	55 x 55	2 1/4" x 2 1/8"
G8A	170IRS 170IRB	160	6 1/4"	298	11 3/4"	57 x 54	Ø2 1/4"
G6A	170IRS 170IRB	180	7 1/8"	276	10 7/8"	Ø 55	Ø2 1/8"
A9F	170IRS 170IRB	136	5 3/8"	230	9 1/8"	Ø 55	Ø2 1/8"
U4A	170IRS 170IRB	136	5 3/8"	231	9 1/8"	Ø 55	Ø2 1/8"
A35	170IRS 170IRB	143	5 5/8"	157	6 1/8"	Ø 55	Ø2 1/8"
G7E	170IRS 170IRB	150	5 7/8"	218	8 5/8"	Ø 55	Ø2 1/8"
G7A	170IRS 170IRB	200	7 7/8"	141	5 1/2"	Ø 55	Ø2 1/8"
G7C	170IRS 170IRB	200	7 7/8"	141	5 1/2"	Ø 55	Ø2 1/8"
U2A	170IRS 170IRB	217	8 1/2"	167	6 5/8"	Ø 55	Ø2 1/8"
G29	170IRS 170IRB	151	6"	166	6 1/2"	Ø 55	Ø2 1/8"
U93	170IRS 170IRB	163	6 3/8"	127	5"	Ø 64	Ø2 1/2"
U9A	170IRS 170IRB	150	5 7/8"	218	8 5/8"	Ø 55	Ø2 1/8"
U9K	170IRS 170IRB	150	5 7/8"	218	8 5/8"	Ø 55	Ø2 1/8"
G9A	170IRS 170IRB	140	5 1/2"	127	5"	Ø 64	Ø2 1/2"
G9C	170IRS 170IRB	140	5 1/2"	127	5"	Ø 64	Ø2 1/2"
G9E	170IRS 170IRB	140	5 1/2"	127	5"	Ø 64	Ø2 1/2"
G9G	170IRS 170IRB	140	5 1/2"	127	5"	Ø 64	Ø2 1/2"
G9J	170IRS 170IRB	140	5 1/2"	127	5"	Ø 64	Ø2 1/2"
A54	170IRS 170IRB	151	6"	166	6 1/2"	Ø 55	Ø2 1/8"

COLLECTIONS - BECS DE LAVABO MURAUX | WALL MOUNTED BASIN SPOUTS



G04



G79



U7G



G1T



G6A



U4A



A9F



U2D



U2M



G4P



G8A



A35



G7E



G7A



G7C



U2A



U9A



U9K



G9A



G9C



G9E



G9G



G9J



U8D



U8F



U8H



U8K



G2T



G69



G29



A54

22 | 22GAB | 22SGAB

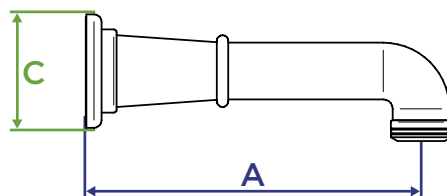

mm : millimètre
inch : pouce

COLLECTIONS	REFERENCES	A		C	
		mm	inch	mm	inch
G04	22GAB	181	7 1/8"	45 x 45	1 3/4" x 1 3/4"
G79	22GAB	190	7 1/2"	70 x 70	2 3/4" x 2 3/4"
U7G	22GAB	170	6 3/4"	65 x 65	2 1/2" x 2 1/2"
G1T	22GAB	135	5 3/8"	55 x 55	2 1/8" x 2 1/8"
G6A	22GAB	185	7 1/4"	Ø 50	Ø2"
U4A	22GAB	188	7 3/8"	Ø 65	Ø2 1/2"
A9F	22GAB	188	7 3/8"	Ø 70	Ø2 3/4"
U2D	22SGAB	219	8 5/8"	Ø 53	Ø2 1/8"
U2M	22SGAB	219	8 5/8"	Ø 62	Ø2 3/8"
G4P	22GAB	200	7 7/8"	Ø 60	Ø2 3/8"
G8A	22GAB	202	7 7/8"	Ø 54	Ø2 1/8"
A35	22GAB	196	7 3/4"	Ø 70	Ø2 3/4"
G7E	22GAB	183	7 1/4"	Ø 55	Ø2 1/8"
G7A	22GAB	177	7"	Ø 60	Ø2 3/8"
G7C	22GAB	178	7"	Ø 60	Ø2 3/8"
U2A	22GAB	163	6 3/8"	Ø 50	Ø2"
U9A	22GAB	190	7 1/2"	Ø 60	Ø2 3/8"
U9K	22GAB	190	7 1/2"	Ø 60	Ø2 3/8"
G9A	22GAB	203	8"	Ø 64	Ø2 1/2"
G9C	22GAB	203	8"	Ø 64	Ø2 1/2"
G9E	22GAB	203	8"	Ø 64	Ø2 1/2"
G9G	22GAB	203	8"	Ø 64	Ø2 1/2"
G9J	22GAB	203	8"	Ø 64	Ø2 1/2"
U8D	22GAB	224	8 7/8"	80 x 45	3 1/8" x 1 3/4"
U8F	22GAB	224	8 7/8"	80 x 45	3 1/8" x 1 3/4"
U8H	22GAB	224	8 7/8"	80 x 45	3 1/8" x 1 3/4"
U8K	22GAB	224	8 7/8"	80 x 45	3 1/8" x 1 3/4"
G2T	22	149	5 7/8"	Ø 75	Ø3"
G69	22	148	5 7/8"	Ø 65	Ø2 1/2"
G29	22GAB	166	6 1/2"	Ø 85	Ø3 3/8"
A54	22SGAB	213	8 3/8"	Ø 65	Ø2 1/2"

COLLECTIONS - BECS DE BAIN MURAUX | WALL MOUNTED BATH SPOUTS



G04



G79

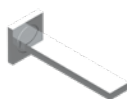

G5E



U7G



G1T



G6A



U4A



A9F



U2D



U2M



G4P



G8A



G25



A35



G5A



G7E



G7A



G7C



U2A



U93



U9A



U9K



G9A



G9C



G9E



G9G



G9J



U8D



U8F



U8H



U8K



G2T



G69



G29



A54

42GB | 42SGB

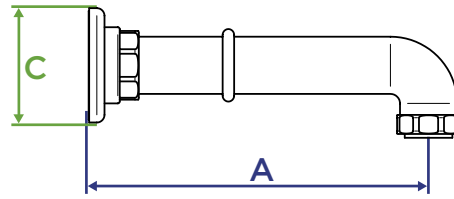

mm : millimètre
inch : pouce

COLLECTIONS	REFERENCES	A		C	
		mm	inch	mm	inch
G04	42GB	181	7 1/8"	45 x 45	1 3/4" x 1 3/4"
	42SBG	220	8 5/8"	50 x 50	2" x 2"
G79	42GB	190	7 1/2"	70 x 70	2 3/4" x 2 3/4"
G5E	42GB	137	5 3/8"	50 x 50	2" x 2"
U7G	42SGB	216	8 1/2"	65 x 65	2 1/2" x 2 1/2"
G1T	42GB	133	5 1/4"	55 x 55	2 1/8" x 2 1/8"
	42SBG	211	8 1/4"	60 x 60	2 3/8" x 2 3/8"
G6A	42GB	185	7 1/4"	Ø 50	Ø2"
	42SBG	225	8 7/8"	Ø 60	Ø2 3/8"
U4A	42GB	188	7 3/8"	Ø 65	Ø2 1/2"
	42SBG	229	9"	Ø 65	Ø2 1/2"
A9F	42GB	188	7 3/8"	Ø 70	Ø2 3/4"
	42SBG	229	9"	Ø 80	Ø3 1/8"
U2D	42SGB	219	8 5/8"	53	Ø2 1/8"
U2M	42SGB	219	8 5/8"	61	2 3/8"
G4P	42GB	202	8"	Ø 60	Ø2 3/8"
G8A	42GB	204	8"	Ø 54	Ø2 1/8"
G25	42GB	261	10 1/4"	Ø 84	Ø3 1/4"
A35	42GB	196	7 3/4"	Ø 70	Ø2 3/4"
	42SBG	203	8"	Ø 70	Ø2 3/4"
G5A	42GB	190	7 1/2"	Ø 44	Ø1 3/4"
G7E	42GB	183	7 1/4"	Ø 55	Ø2 1/8"
G7A	42GB	177	7"	Ø 60	Ø2 3/8"
	42SBG	227	8 7/8"	Ø 60	Ø2 3/8"
G7C	42GB	178	7"	Ø 60	Ø2 3/8"
	42SBG	228	9"	Ø 60	Ø2 3/8"
U2A	42SGB	203	8"	Ø 50	Ø2"
U93	42GB	223	8 3/4"	Ø 60	Ø2 3/8"
U9A	42GB	190	7 1/2"	Ø 60	Ø2 3/8"
U9K	42GB	190	7 1/2"	Ø 60	Ø2 3/8"
	42SBG	207	8 1/8"	Ø 75	Ø3"
G9A	42GB	203	8"	Ø 64	Ø2 1/2"
G9C	42GB	203	8"	Ø 64	Ø2 1/2"
G9E	42GB	203	8"	Ø 64	Ø2 1/2"
G9G	42GB	203	8"	Ø 64	Ø2 1/2"
G9J	42GB	203	8"	Ø 64	Ø2 1/2"
U8D	42SGB	224	8 7/8"	80 x 45	3 1/8" x 1 3/4"
U8F	42SGB	224	8 7/8"	80 x 45	3 1/8" x 1 3/4"
U8H	42SGB	224	8 7/8"	80 x 45	3 1/8" x 1 3/4"
U8K	42SGB	224	8 7/8"	80 x 45	3 1/8" x 1 3/4"
G2T	42SGB	239	9 3/8"	Ø 75	Ø3"
G69	42SGB	238	9 3/8"	Ø 65	Ø2 1/2"
G29	42GB	166	6 1/2"	Ø 85	Ø3 3/8"
	42SBG	221	8 3/4"	Ø 85	Ø3 3/8"
A54	42SGB	213	8 3/8"	Ø 65	Ø2 1/2"

COLLECTIONS - BECS DE BAIN | BATH SPOUTS



G04



G79



G5E



U7G



G1T



G6A



U4A



U2D



U2M



G4P



G25



G8A



A35



G5A



G7E

44



G7A



G7C



U2A



U93



U9A



U9K



G9A



G9C



G9E



G9G



G9J



U8D



U8F



U8H



U8K



G2T



G69



G29

29 | 29H | 29SG | 29SGB | 29SGH

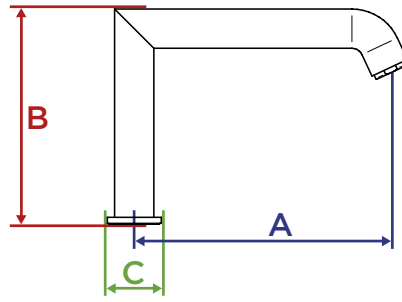

mm : millimètre
inch : pouce

COLLECTIONS	REFERENCES	A		B		C	
		mm	inch	mm	inch	mm	inch
G04	29	179	7"	230	9"	50 x 55	2" x 2 1/8"
G79	29	171	6 3/4"	202	8"	60 x 60	2 3/8" x 2 3/8"
G5E	29SG	179	7"	262	10 3/8"	50 x 50	2" x 2"
U7G	29SG	171	6 3/4"	221	8 5/8"	65 x 65	2 1/2" x 2 1/2"
G1T	29	192	7 1/2"	183	7 1/4"	65 x 65	2 1/2" x 2 1/2"
G6A	29	180	7 1/8"	246	9 5/8"	Ø 50	Ø2"
U4A	29SG	166	6 1/2"	245	9 5/8"	Ø 65	Ø2 1/5"
A9F	29SG	166	6 1/2"	245	9 5/8"	Ø 70	Ø2 3/4"
U2D	29SG	180	7 1/8"	273	10 3/4"	40 x 60	1 5/8" x 2 3/8"
U2M	29SG	156	6 1/8"	270	10 5/8"	73 x 66	2 7/8" x 2 5/8"
G4P	29SG	215	8 1/2"	352	13 7/8"	Ø 60	Ø2 3/8"
G25	29SG	220	8 5/8"	234	9 1/4"	Ø 70	Ø2 3/4"
G8A	29SG	215	8 1/2"	352	13 7/8"	Ø 57	Ø2 1/4"
A35	29SG	210	8 1/4"	181	7 1/8"	Ø 65	Ø2 1/2"
G5A	29SGB	210	8 1/4"	175	6 7/8"	Ø 50	Ø2"
	29SGH	215	8 1/2"	316	12 1/2"	Ø 50	Ø2"
G7E	29SGB	220	8 5/8"	155	6 1/8"	Ø 55	Ø2 1/8"
	29SGH	180	7 1/8"	285	11 1/4"	Ø 55	Ø2 1/8"
G7A	29SG	200	7 7/8"	127	5"	Ø 60	Ø2 3/8"
G7C	29SG	200	7 7/8"	129	5 1/8"	Ø 60	Ø2 3/8"
U2A	29SG	191	7 1/5"	145	5 3/4"	Ø 50	Ø2"
U93	29	163	6 3/8"	106	4 1/8"	Ø 65	Ø2 1/2"
U9A	29SGB	220	8 5/8"	126	5"	Ø 75	Ø3"
	29SGH	180	7 1/8"	298	11 3/4"	Ø 60	Ø2 3/8"
U9K	29SGB	220	8 5/8"	126	5"	Ø 75	Ø3"
	29SGH	180	7 1/8"	298	11 3/4"	Ø 60	Ø2 3/8"
G9A	29	201	7 7/8"	96	3 3/4"	Ø 64	Ø2 1/2"
	29H	201	7 7/8"	168	6 5/8"	Ø 64	Ø2 1/2"
G9C	29	201	7 7/8"	96	3 3/4"	Ø 64	Ø2 1/2"
	29H	201	7 7/8"	168	6 5/8"	Ø 64	Ø2 1/2"
G9E	29	201	7 7/8"	96	3 3/4"	Ø 64	Ø2 1/2"
	29H	201	7 7/8"	168	6 5/8"	Ø 64	Ø2 1/2"
G9G	29	201	7 7/8"	96	3 3/4"	Ø 64	Ø2 1/2"
	29H	201	7 7/8"	168	6 5/8"	Ø 64	Ø2 1/2"
G9J	29	201	7 7/8"	96	3 3/4"	Ø 64	Ø2 1/2"
	29H	201	7 7/8"	168	6 5/8"	Ø 64	Ø2 1/2"
U8D	29SG	220	8 5/8"	102	4"	55	2 1/8"
U8F	29SG	220	8 5/8"	102	4"	55	2 1/8"
U8H	29SG	220	8 5/8"	102	4"	55	2 1/8"
U8K	29SG	220	8 5/8"	102	4"	55	2 1/8"
G2T	29SG	220	8 5/8"	116	4 5/8"	Ø 60	Ø2 3/8"
G69	29SG	220	8 5/8"	115	4 1/2"	Ø 55	Ø2 1/8"
G29	29SGB	225	8 7/8"	101	4"	Ø 66	Ø2 5/8"
	29SGH	235	9 1/4"	180	7 1/8"	Ø 60	Ø2 3/8"

FINITIONS | FINISHES

Plus de finitions disponibles sur THG-PARIS.COM

For more finishes and additional information, please visit THG-PARIS.COM



A02
Chrome
Polished chrome



B01
Nickel
Polished nickel



C01
Nickel mat
Matt nickel



H03
Vieil argent
vernis brillant
Lacquered
antique silver



H62
PVD couleur
blush
Blush color
PVD



H60
PVD couleur
blush mat
Matt blush
color PVD



F30
Or pâle
Soft gold



F31
Or pâle mat
Soft matt gold



F01
Doré
Polished gold



F07
Doré mat
Matt gold



D01
Bronze clair
vernis brillant
Lacquered
light bronze



D05
Bronze clair
vernis mat
Lacquered
matt bronze

46



H64
PVD couleur
graphite
Graphite color
PVD



H65
PVD couleur
graphite mat
Matt graphite
color PVD



H55
PVD couleur
nickel
Nickel color
PVD



H56
PVD couleur
nickel mat
Matt nickel
color PVD



H66
PVD couleur
umber
Umber color
PVD



H67
PVD couleur
umber mat
Matt umber
color PVD



H52
PVD couleur
doré
Gold color
PVD



H53
PVD couleur
doré mat
Matt gold
color PVD



H49
PVD couleur
laiton
Brass color
PVD



H50
PVD couleur
laiton mat
Matt brass
color PVD



F33
PVD couleur
bronze brown
Brown bronze
color PVD



F34
PVD couleur
bronze brown mat
Matt brown
bronze color PVD

CONTACT

SIÈGE SOCIAL | HEAD OFFICE

THG FRANCE

35, rue Tournière - BP 80212
Béthencourt-sur-Mer
80535 Friville cedex - France
+33 (0)3 22 60 20 80
contact@thg.fr
www.thg-paris.com

FILIALES | SUBSIDIARIES

THG USA LLC

Head office
441 NW - 1st avenue
Fort Lauderdale
FL 33301 - USA
Tel. +1 954 425 8225
info@thgusa.com

THG DEUTSCHLAND GMBH

Gutleutstr. 96
60329 Frankfurt/Main
Deutschland
Tel. +49 (0)69/ 25 78 14 33
info@thg-deutschland.de

THG UK

11 Commercial Way,
London NW10 7XF
United Kingdom
Tel. +44 (0)20 8202 8288
salesuk@thg-paris.com

THG ASIA

Room 1901, Rui Jin Building
205 South Maoming Road
Shanghai - PRC
上海市卢湾区茂名南路205号瑞金大厦1901室
电话/ Tel. +86 (21) 613 527 38
contact@thg-asia.cn

THG RUSSIA

Leningradskiy avenue,
bld. 37A, housing 14
125167 Moscow - Russia
Tel. +7 495 800 8225
thg@thg-russia.ru

THG MIDDLE EAST

Alan Haddad
Dubai Design District
Building 3, Office 605
Dubai, UAE
Tel. +971 508 456 003
contact@thg-paris.com

SHOWROOMS THG | THG SHOWROOMS

PARIS

152 bd Haussmann
75008 Paris - France
Tel. +33 (0)1 44 20 09 20
contact@thg-bathconcept.com
www.thg-bathconcept.com

LONDON

4 Pont Street
London SW1X 9EL
United Kingdom
Tel. +44 (0)20 7838 7788
salesuk@thg-paris.com
london.thg-paris.com

NEW YORK

D&D Building
Showroom 1206 - 12th floor
979 Third Avenue - New-York
NY 10022 - USA
Tel. +1 (917) 242 8911
info@thgusa.com

FRANKFURT

Gutleutstr. 96
60329 Frankfurt/Main
Deutschland
Tel. +49 (0)69/ 25 78 14 33
info@thg-deutschland.de

CRÉDITS | CREDITS

CONCEPTION ET RÉALISATION

THG Paris

Textes et photos non contractuels et susceptibles d'être modifiés sans préavis
| Text and pictures are not binding and can be modified without any previous
notice

© THG Paris Juillet 2021



Entreprise
du Patrimoine
Vivant
L'excellence
des savoir-faire
français



FABRICANT FRANÇAIS

THG[®]
P A R I S